



ISOMECH
SANDWICH PANELS





Standard		A richiesta all'ordine At request at the order		Over Lapping	
----------	---	---	---	-----------------	---

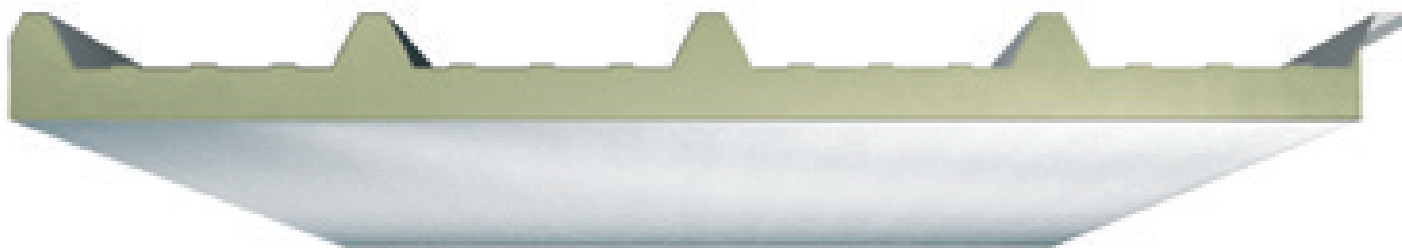

Pannello metallico autoportante coibentato in poliuretano destinato alle coperture inclinate con pendenza minima 7%. Il lato interno del pannello è realizzato con un rivestimento superficiale costituito da alluminio centesimale gofrato. Giunto incastro maschio/femmina classico da copertura. Il fissaggio è di tipo passante con possibilità utilizzo di capellotti. Estremamente economico in condizioni normali di esercizio.

L'utilizzo corretto è previsto con il supporto rigido in lamiera rivolto verso l'alto, su sotto struttura continua (tavolato piano, solaio in calcestruzzo).

A self-supporting metal panel insulated in polyurethane designed for sloping roofs with a minimum slope of 7%. The inner side of the panel has a surface covering of embossed aluminium foil. Classic roofing male/female joints. The fixing is feed-through and cap nuts can be used. Extremely economical in normal conditions of use.

It must be laid with the rigid sheet metal surface facing upward on a continuous sub-structure (flat planking, concrete flooring).

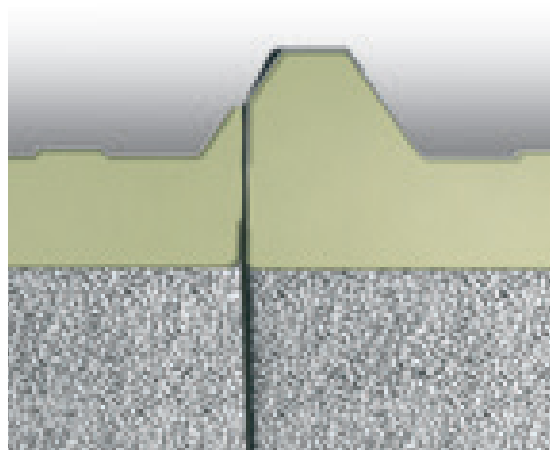
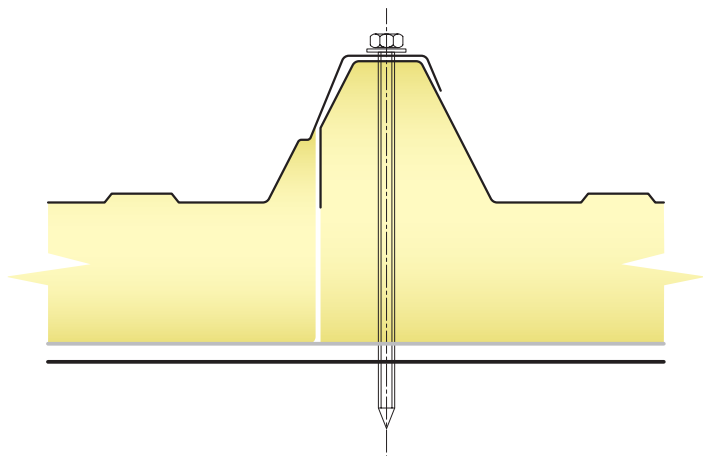



Micronervature

Profile types

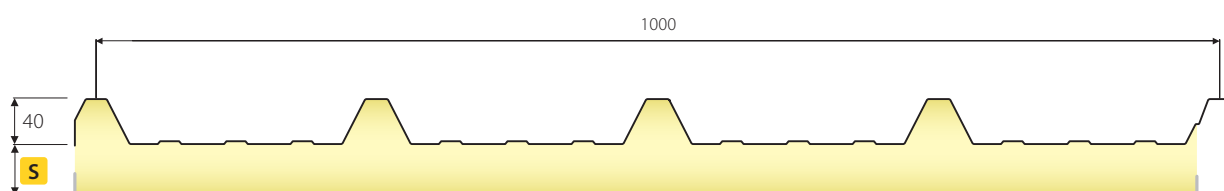

ISOCOP CA	Standard	A richiesta – On demand
Finiture esterne - External finishing	5G	3G
Finiture interne - Internal finishing	Nastro d'alluminio ricotto (lega 8079) per coibentazione. Disponibile gofrato, di spessore 0,080 mm, laccato con lacca a base di resina poliestere su lato opaco e laccato con lacca termosaldante per poliuretani a base di resina vinilica sul lato lucido. Carico a rottura (Al liscio) >60N/mm ² ; allungamento > 8%	Insulating-grade annealed aluminium strip (8079 alloy). Centesimal aluminium is available embossed, thickness 0.080 mm, painted with polyester resin based varnish on matt side and vinyl resin-based, heat-seal varnish for polyurethanes on the glossy side. Load at break (smooth) >60N/mm ² ; lengthening > 8%.
Superfici esterne External surface	Acciaio-Steel EN10346/Inox EN10088 Alluminio-Aluminium EN485	Granite-Color Farm/Plastisol/Aluzinc HDX/Z150-275 - PET - PVDF - PVC
Isolanti - Insulating	PUR3	PUR2 - PIR - POLYISO - IPN

Proprietà meccaniche Acciaio - Mechanical Properties: Steel														
S (mm)	Peso Weight (kg/m ²)	K (W/m ² K)	S (mm)	L (m)	L					L				
					1,00	1,50	2,00	2,50	3,00	1,00	1,50	2,00	2,50	3,00
10	5,20	2,22	0,5	Portata Max Load P=kg/m ²	460	200	115			560	240	130	80	
15	5,50	1,46			560	245	130	70		680	300	165	100	65
30	6,20	0,73	0,6	Portata Max Load P=kg/m ²	660	290	150	80		850	375	200	130	80
40	6,60	0,55			760	340	180	90	55	1000	445	245	150	100
50	7,00	0,44	0,7	Portata Max Load P=kg/m ²										
60	7,40	0,37												
80	8,20	0,28	0,8	Portata Max Load P=kg/m ²										
100	9,00	0,22												

I dati riportati sono puramente indicativi. Rimane responsabilità del progettista, in fase di calcolo, effettuare le verifiche necessarie. Per maggiori informazioni contattare Isomec.
 Technical data are to be considered as purely indicative. They can not replace the project calculation made by a qualified technician who will apply the rules in force in the referring market. More info, please contact: Isomec.



Contacts

Contatti

Finance - Management

Amministrazione

Viale del lavoro 19, Z.I. Paludi

32016 Alpago (BL)

Ph. +39 0437 989105

Fax +39 0437 989198

www.isomec.it

Sales - Logistics

Uffici - Commerciali - Logistica

Viale del lavoro 19, Z.I. Paludi

32016 Alpago (BL)

Ph. +39 0437 989105

Fax +39 0437 989198

www.isomec.it

Production and registered office

Produzione e sede legale

Viale del lavoro 31, Z.I. Paludi

32016 Alpago (BL)

Ph. +39 0437 989206

Fax +39 0437 982084

www.isomec.it

Mail:

Information - Informazioni:

isomec@isomec.it

Finance - Amministrazione:

amministrazione@isomec.it

Accounting - Contabilità:

contabile@isomec.it

Sales - Vendite:

commerciale@isomec.it

Logistics - Logistica:

spedizioni@isomec.it

Production - Produzione:

produzione@isomec.it